

MARK
CENTER OF
DOOR
THICKNESS
FOR 1" DIA.
HOLE

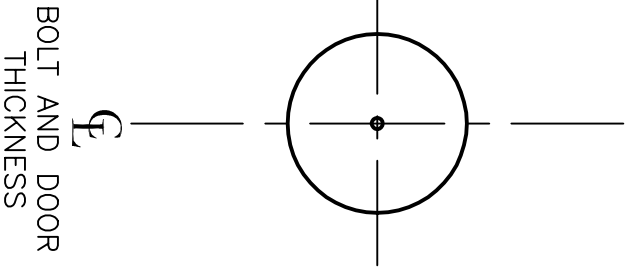

TEAR HERE

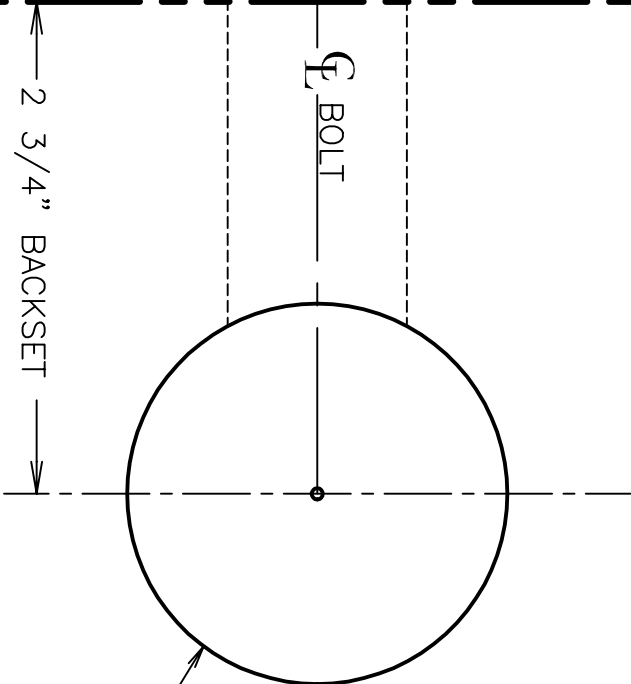

NOTE: ADJUST
TEMPLATE FOR
BEVELED DOORS

$\phi 2\frac{1}{8}$



DOOR TEMPLATE



DATE: 1-5-00

KV, KM, KR 137 DRIVE IN BOLT
2 3/4" BACKSET (FIXED)

MAY NOT BE TO SCALE

PLEASE ENSURE THAT THIS IS THE MOST UP
TO DATE TEMPLATE BY VISITING OUR
WEBSITE AT WWW.PDQLOCKS.COM